

Verbrennungsgasföhrrohr 125 mm DM

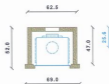

Maßstab: Schliser _____

Einseitig 2013 27.08.2013

M 1 : 20 *bed*

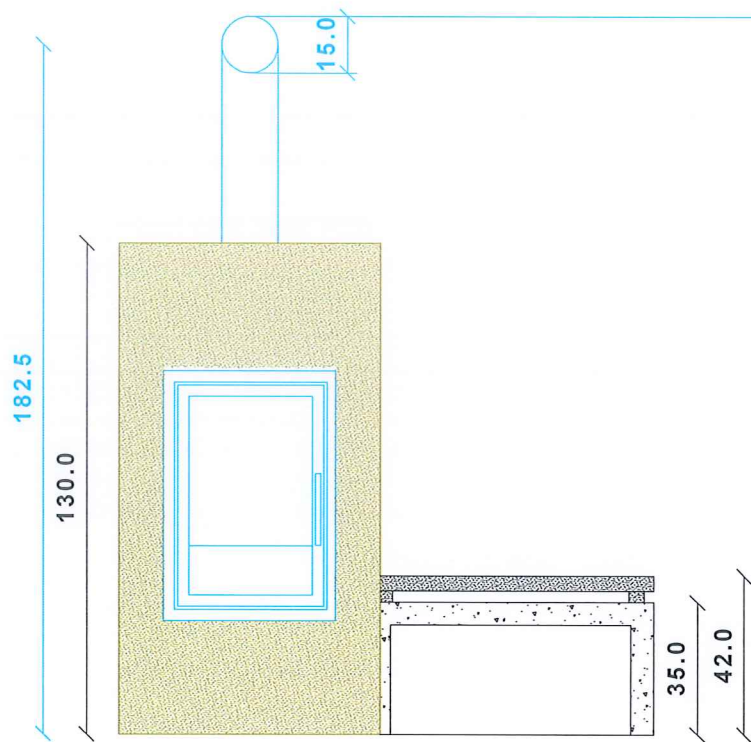

FRONT

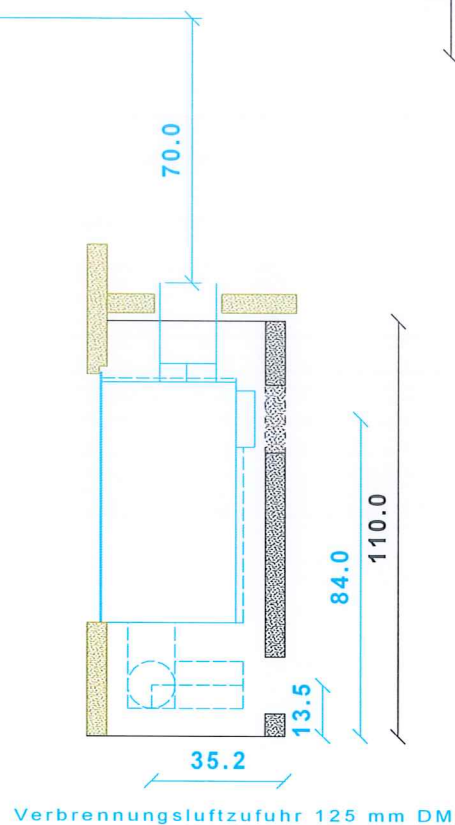

RECHTS

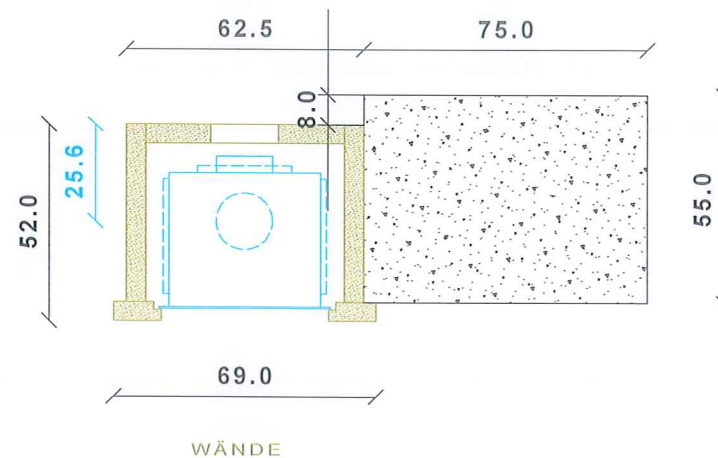

Maßblatt: Banksockel

Einsatz 2020

10.03.2020

M 1 : 20

hst

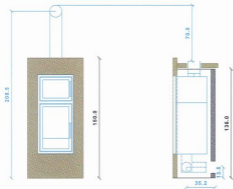

Verbreiterungsstutzenrohr 185 mm DM

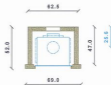

Maßblatt: Backofen

Einheit: 2019

27.09.2019

M 1 : 20

sch

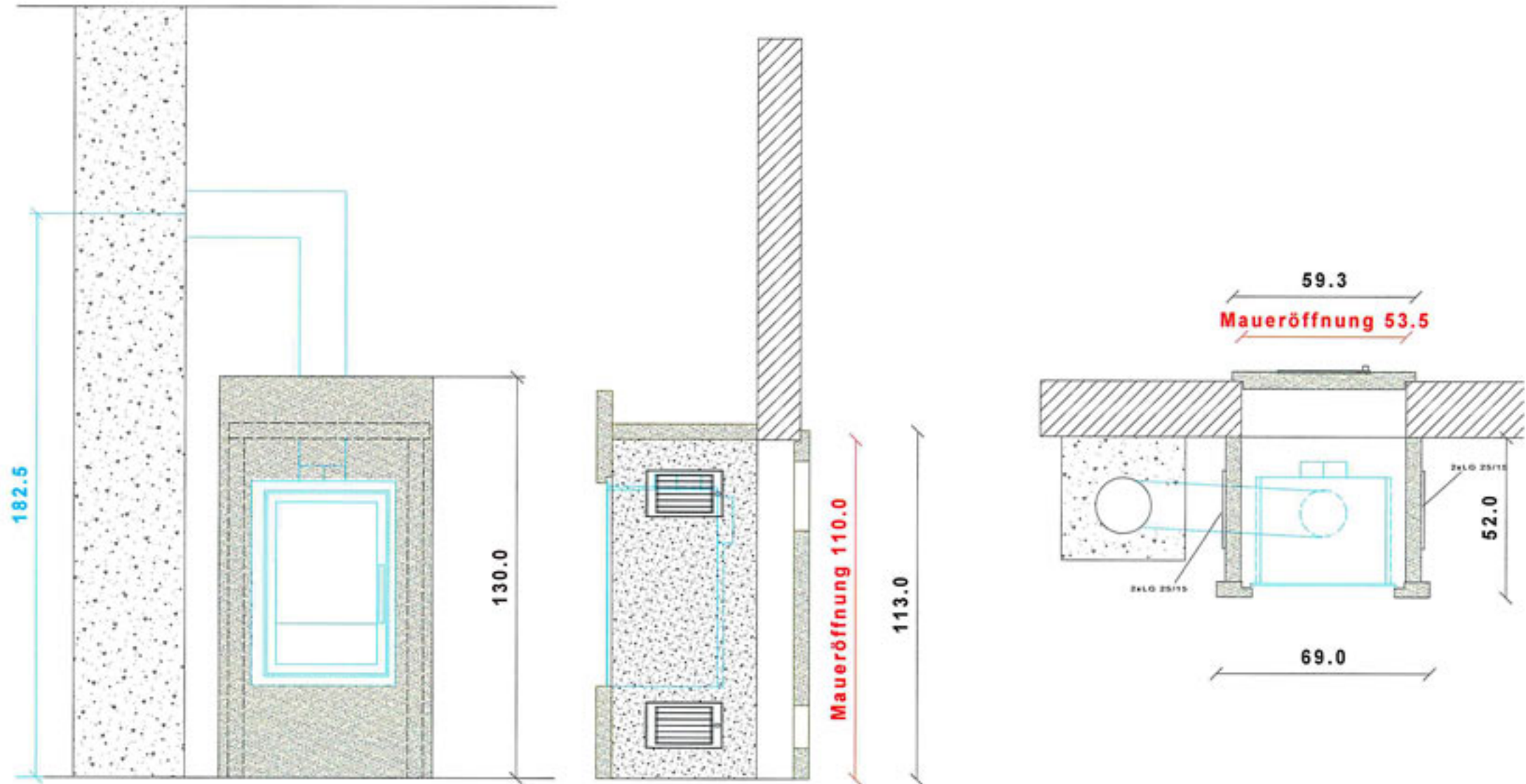

Technische Maß- und Konstruktionsänderung vorbehalten

Maßblatt: Nebenraum
 Einsatz 2013 27.03.2013
 M 1 : 20 *hst*

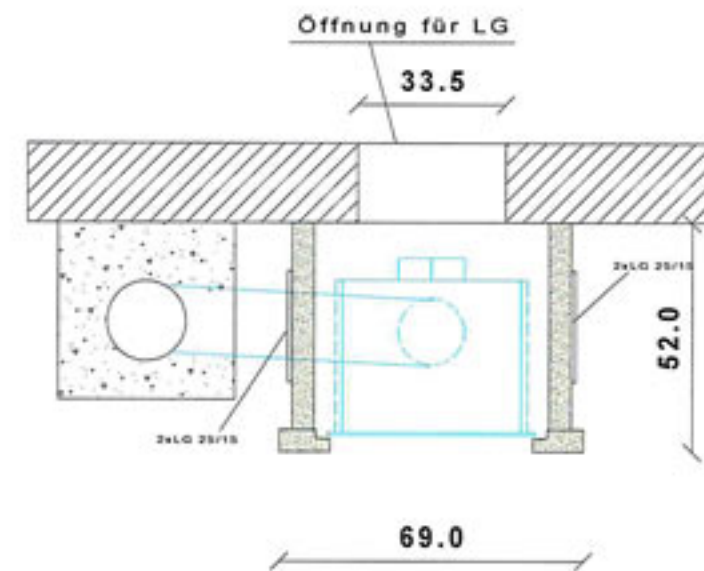
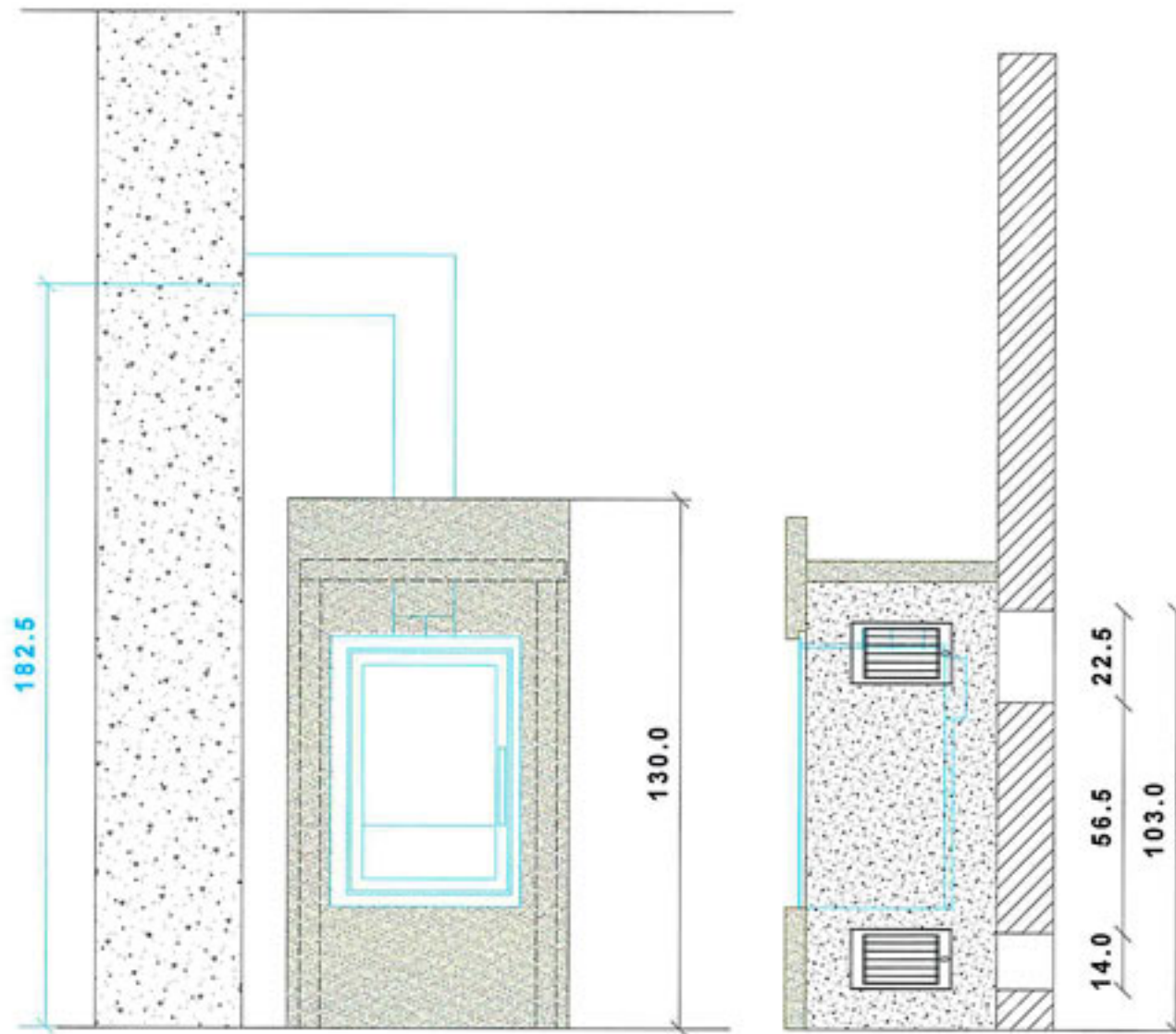

Technische Maß- und Konstruktionsänderung vorbehalten

Maßblatt: Nebenraum o. Wand

Einsatz 2013

27.03.2013

M 1 : 20

hst

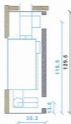
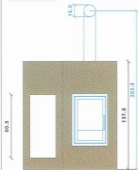

Verbrennungsluftzufuhr 125 mm Ø

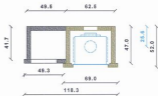

Maßblatt: Holzofen

Eintrag: 2019

27.03.2019

M 1 : 20

h



LINKS



FRONT



RECHTS

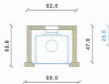

Topplatte ins Koch mit LG

Einseitig 2013 05.05.2014

M 1 : 20 H₁₀

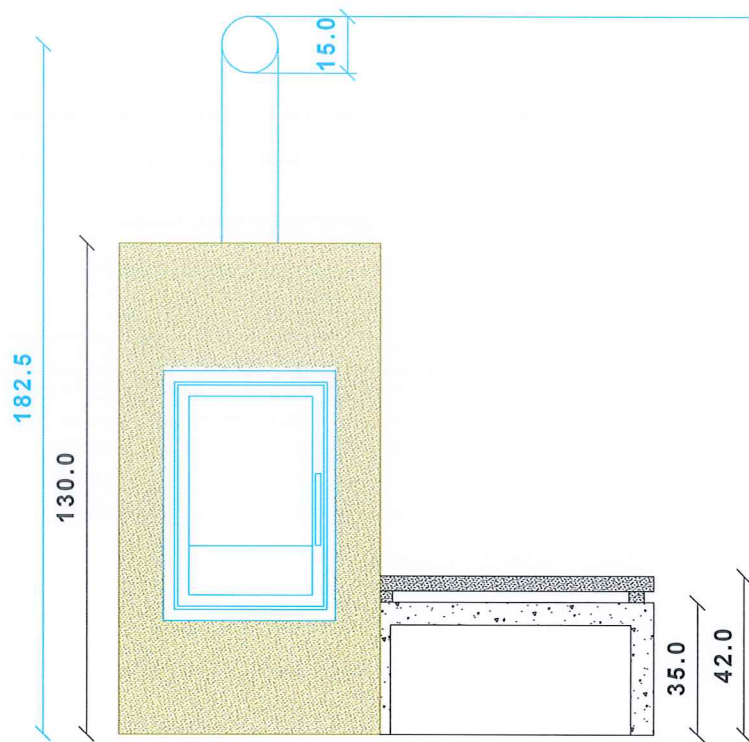

FRONT

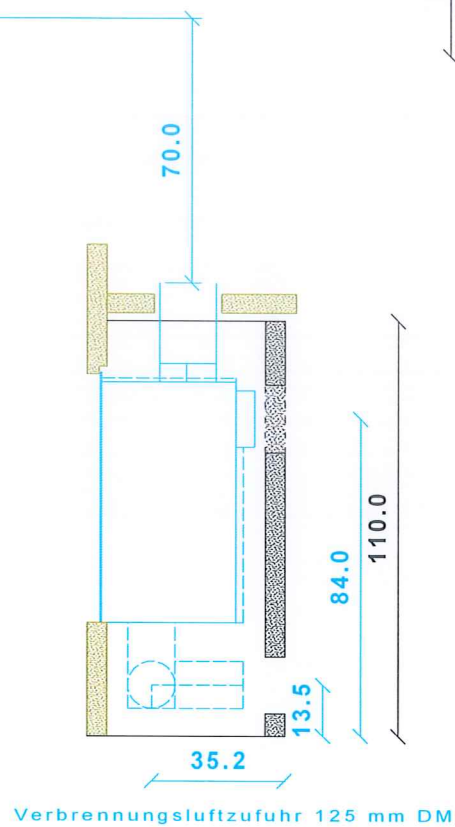

RECHTS

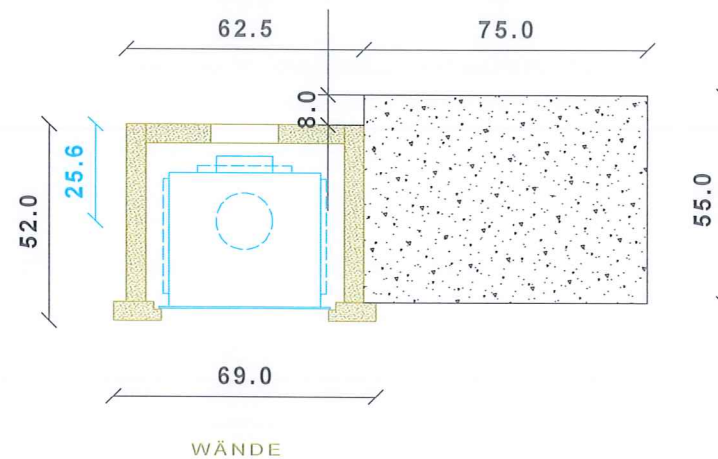

Maßblatt: Banksockel

Einsatz 2020

10.03.2020

M 1 : 20

hst

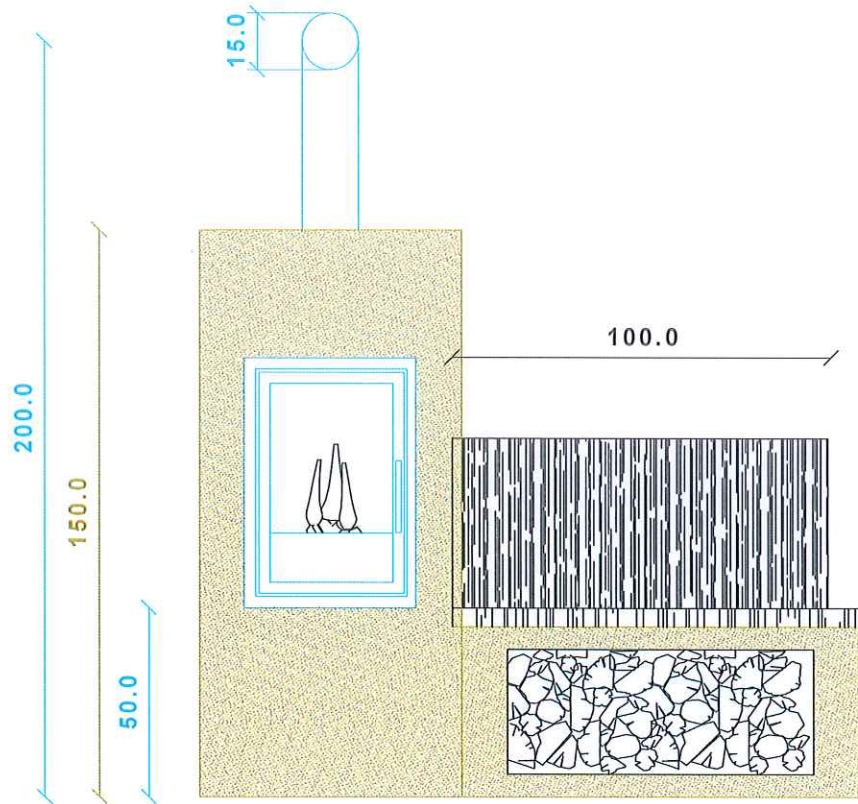

FRONT

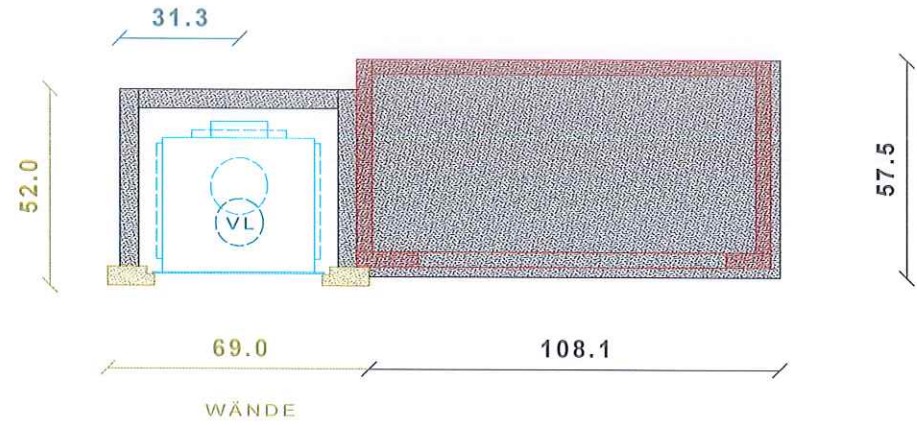

RECHTS

Verbrennungsluftdurchmesser 125mm

Technische Maß- und Konstruktionsänderung vorbehalten

Basis-Edition EBH50 HLB + RL

Einsatz 2018 30.04.2019

M 1 : 20

Mal